



DANGER



**THIS TOOL FOR USE BY LICENSED OPERATORS ONLY.
READ AND OBEY ALL SAFETY AND OPERATING
INSTRUCTIONS BEFORE OPERATING TOOL.**



Ramset[®]

**XT540 TOOL
OPERATOR'S
SAFETY & OPERATING
INSTRUCTION MANUAL**



**SEMI-AUTOMATIC, LOW VELOCITY
PISTON TYPE FASTENING TOOL**



DANGER



THIS TOOL IS TO BE USED ONLY BY PROPERLY TRAINED AND LICENSED OPERATORS.

YOU MUST SUCCESSFULLY COMPLETE THE RAMSET TRAINING PROGRAM FOR THE TOOL AND OBTAIN A CERTIFIED OPERATOR'S LICENSE BEFORE HANDLING, LOADING OR OPERATING THIS TOOL.

ATTEMPTING TO HANDLE OR OPERATE THIS TOOL WITHOUT PROPER TRAINING AND LICENSING CAN RESULT IN SERIOUS INJURY TO THE OPERATOR OR BYSTANDERS.

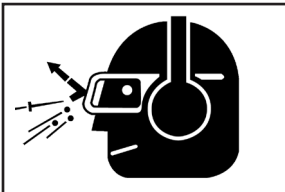

Operator's and bystanders must wear eye and hearing protection.

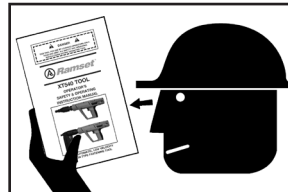

Read manual before operating tool.

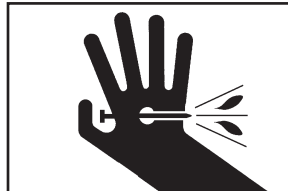
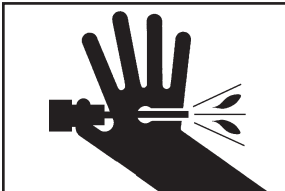

Never close tool with hand over fastener loading end of the tool. A serious hand injury from penetration by the piston or a discharged fastener could result.



DANGER



Just as no one can merely read a book about driving an automobile and then hope to drive one safely, no one should attempt to use any Ramset tool without adequate, competent personal instruction. And just as one must be licensed to drive an automobile, one must also be licensed to use a powder actuated tool. No automobile instruction book or instructor can forewarn a learner against all possibilities and emergencies, nor can Ramset instructors and printed material detail all possible conditions surrounding the use of Ramset tools and products.

Responsibility for the safe and proper use of this tool rests with the tool user and the employer.



Preparation

Acceptable Base Materials

Powder actuated fastening is suitable for use in the following base materials only:

- Poured Concrete
- Structural Steel
- Masonry Joints (see page 8)

Never attempt to fasten into any other type of material. Fastening into other materials can cause blindness or other serious injury.

Unacceptable Base Materials

Never attempt to fasten into very hard or brittle materials such as cast iron, tile, glass, or rock of any type. These materials can shatter, causing the fastener and/or base material fragments to fly free and cause serious injury to the tool operator and others.

Never fasten into soft base materials, such as drywall or lumber products. These materials may allow the fastener to travel completely through and out the other side, endangering those in the path of the fastener.

Never fasten into any base material that does not pass the Center Punch test. Failure to assure the suitability of the base material can result in serious injury to the eyes or other body parts.

Center Punch Test

ALWAYS WEAR SAFETY GOGGLES WHEN PERFORMING THIS TEST.

1. Always check the material being fastened into for hardness before attempting any fastening operation.
2. Using a fastener as a center punch, strike the fastener against the work surface using an average hammer blow and check the results.

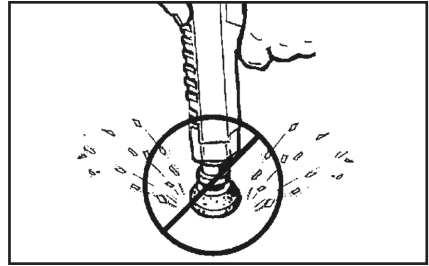

NEVER FASTEN INTO VERY HARD OR BRITTLE MATERIALS

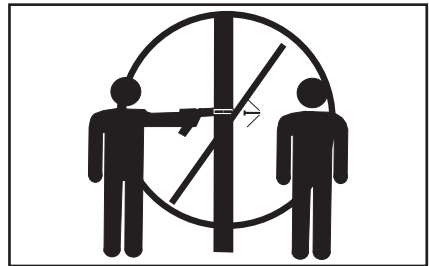

NEVER FASTEN INTO SOFT MATERIALS SUCH AS DRYWALL

Center Punch Test Results

1. If the fastener point is flattened, the material is too hard for a powder actuated fastening.
2. If the fastener penetrates the material easily, the material is too soft.
3. If the material cracks or shatters, the material is too brittle.
4. If the fastener makes a small indentation into the material, the material is suitable for fastening.

Loads & Load Selection Safety

- 1. Always make a test fastening after being sure that the base material is suitable for powder actuated fastening.** *Failure to determine the correct power level to be used may result in the use of excessive power, allowing the fastener to pass completely through the work material, causing serious or fatal injuries to others who may be in the path of the fastener.*
- 2. Color-blind operators must always select loads by number to prevent use of an incorrect load for the same reasons as in #1 above.**

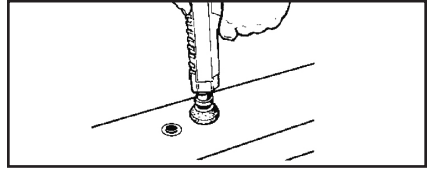

ALWAYS MAKE A TEST FASTENING

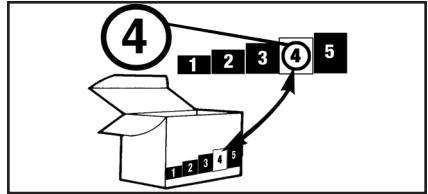

COLOR-BLIND OPERATORS MUST ALWAYS SELECT LOADS BY NUMBER

Workplace Safety

- 1. Operators and bystanders must always wear approved eye protection and approved hearing protection.** *Failure to do so may result in blindness or serious eye injury from flying debris and loss of hearing from constant or repeated unprotected exposure to fastening noise.*
- 2. Always keep the work area clear of bystanders and unnecessary materials that could interfere with safe tool operation.** *Operating the tool in a congested or cluttered area may affect your ability to operate the tool safely.*
- 3. Never operate tool if flammable or explosive materials are nearby.** *Powder loads burn and create sparks when fired and could ignite these materials or fumes.*
- 4. Always post warning signs within 50 ft. of the area where fastening is to be done. Sign must state: "WARNING - Powder Actuated Tool In Use".** *Failure to warn others may result in serious injury to them. Contact Ramset at 1-800-241-5640 to obtain this sign.*



KEEP WORK AREA CLEAR OF BYSTANDERS AND CLUTTER



NEVER OPERATE THE TOOL AROUND FLAMMABLE OR EXPLOSIVE MATERIALS



ALWAYS POST WARNING SIGNS

Tool Handling Safety

1. Always be sure tool is operating properly before attempting to use it. Follow the “Daily Function Test” shown to the right and described on page 9.
2. Always load tool using a strip load selected directly from a box indicating the power load type and number. Never attempt to use loose strip loads that could be mis-identified.
3. Never carry loose loads in pockets with pins or other hard objects.
4. Never load a tool unless you intend to immediately make a fastening. *Loading a tool and leaving it unattended in the work area can result in the tool being accidentally discharged by others.*
5. Never place your hand or any other body part over the fastener loading end of the tool. *Serious hand injury could result from being struck by either a fastener or the tool piston should the tool be accidentally fired.*
6. Always store the tool unloaded and keep the tool and the loads securely locked in a tool box. Keep keys away from children and unlicensed persons.
7. Always keep the tool pointed away from yourself and others.
8. Never carry a loaded tool around the work area.
9. Never allow anyone not trained to use the tool.
10. Never engage in horseplay with the tool.
11. Using the tool in poorly ventilated areas, cleaning tool or handling loads may result in exposure to lead or other substances known to cause birth defects, and other physical harm. Have adequate ventilation at all times and wash thoroughly after exposure.

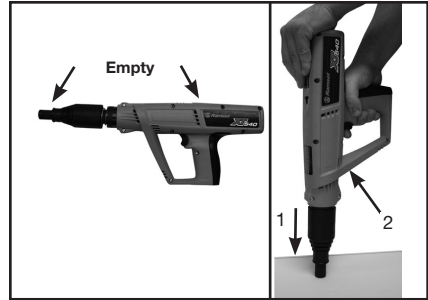

ALWAYS DO A DAILY FUNCTION TEST BEFORE LOADING TOOL

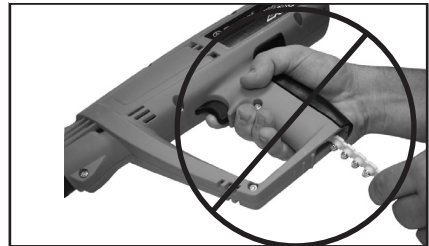

NEVER LOAD THE TOOL UNLESS IT IS TO BE USED IMMEDIATELY



NEVER PLACE HANDS OR BODY OVER MUZZLE OPENING

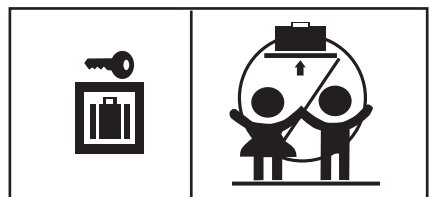

KEEP TOOL LOCKED & OUT OF THE REACH OF CHILDREN



FAILURE TO FOLLOW INSTRUCTIONS CAN CAUSE INJURY TO THE TOOL OPERATOR OR TO BYSTANDERS.

Fastener Driving Safety

1. Only use the tool for fastening into a suitable base material.
2. Never fire the tool without a fastener. *Firing a tool without a fastener will cause the piston to strike the work surface, and may cause serious injury to you and others in the work area.*
3. Always use the spall guard whenever possible to minimize flying particles or debris.
4. Always hold the tool perpendicular to and firmly against the work surface when making a fastening. *Failure to do so could allow a fastener to ricochet.*
5. Never attempt to drive a fastener close to an edge or to another fastener. See page 8 for guidelines.

ALWAYS FOLLOW THE MISFIRE PROCEDURE.

If the tool does not fire after the normal firing sequence, continue to hold the depressed tool against the work surface for at least 30 seconds. Then carefully lower the tool, remove the strip load, and put it in a can of water or other non-flammable liquid. Never carelessly discard a strip with live loads into a trash container.

If the tool becomes stuck or jammed with a live powder load, keep the tool pointed in a safe direction, and immediately tag it, "Danger- defective - do not use". Lock the tool in a tool box and call your local Ramset distributor for assistance.

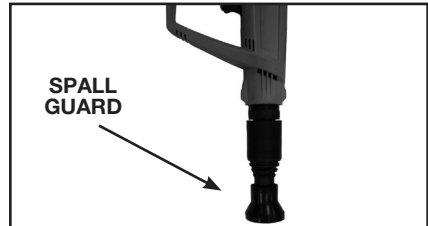

USE SPALL GUARD WHENEVER POSSIBLE

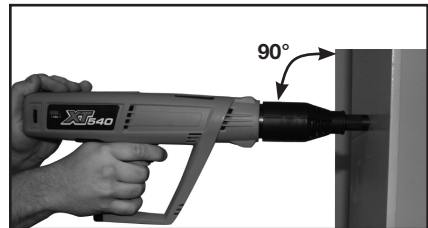

ALWAYS HOLD THE TOOL PERPENDICULAR TO THE WORK SURFACE

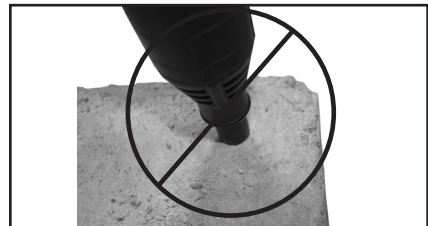

NEVER DRIVE A FASTENER CLOSE TO AN EDGE

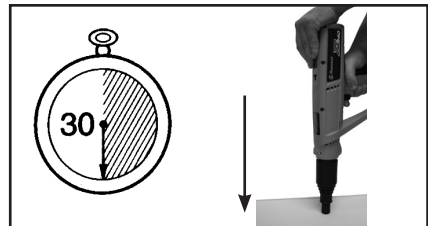

HOLD THE TOOL FIRMLY AGAINST THE WORK SURFACE FOR AT LEAST 30 SECONDS



FASTENERS / LOADS

Your Ramset XT540 Tool uses only the Ramset fasteners and loads shown below or listed for the tool in the Product Catalog.



DANGER



Never use any other types of fasteners or strip loads in the Ramset XT540 Tool. Use of other types of fasteners or loads may cause unintentional load discharge, damage the tool, cause poor fastening performance, or create a risk of serious injury to the operator or bystanders.

FASTENERS

.300 HEAD PLASTIC FLUTED DRIVE PINS

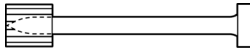

.145 Shank Diameter in Shank Lengths from 1/2" to 3"

.300 HEAD PLASTIC FLUTED DRIVE PINS WITH 7/8" WASHER

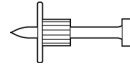

.145 Shank Diameter in Shank Lengths from 1" to 3"

1/4" - 20 THREADED STUDS

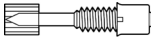

.145 Shank Diameter in Shank Lengths of 1/2" and 1" and Thread Lengths of 1/2", 3/4" and 1"

.300 HEAD POWER POINT PLASTIC FLUTED DRIVE PINS

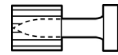

.150 Straight Shank in Shank Lengths from 1/2" to 3/4"

.150/.180 Step Shank in Lengths from 1" to 1-7/8"

8 mm HEAD TOP-HAT DRIVE PINS



.145 Shank Diameter in Shank Lengths from 1/2" to 1"

TE PINS



.157 Diameter 1/2 to 1-1/2

CONDUIT CLIP ASSEMBLIES



For 1/2" and 3/4" Diameter Conduit with 1" Premounted Fastener

CEILING CLIP ASSEMBLIES



Ceiling Clip with 1" or 1-1/4" premounted .145 Shank Pin and Ceiling Clip with 1" or 1-1/4" Premounted .150/.180 Shank Pin

LOADS

Ramset RS27 strip loads are specially made for use in the Ramset XT540 Tool.



RS27 10 SHOT STRIP LOAD

The power level of the load is indicated by the number marked on each box, the color of the box, and the color on the tip of each load. As the number increases, the power level also increases.

POWER LEVEL	CATALOG NUMBER	LOAD COLOR	CASE COLOR
3	3RS27	Green	Brass
4	4RS27	Yellow	Brass
5	5RS27	Red	Brass

Always perform the center punch test described on page 3 to test the base material.

Always make a test fastening using the lowest power level first. If more power is required to set the fastener, use the next higher power level until the powder level necessary to drive the fastener is reached.

FASTENERS / LOADS

FASTENING APPLICATIONS

FASTENING APPLICATIONS

Your Ramset tool can be used for a wide range of fastening needs in a variety of base materials. Reading and follow these important fastening guidelines will help you get the best results from your tool, fasteners, and powder loads, as well as help you perform these fastening operations safely and effectively.

Powder actuated fastenings are permanent fastening so attempting to remove a fastener from concrete or steel may result in serious injury.

Fastening to Concrete

When fastening into concrete, always maintain a minimum spacing of 3" between fastenings and 3" from any free edge. Concrete thickness should be at least three times the intended penetration depth into the concrete. The primary exception to the 3" edge distance can occur in a sill plate application where, by necessity, the edge distance is reduced.

Driving fasteners too close to an edge or too close to each other can cause the concrete edge to fail or fasteners to fly free.

Fastening to Concrete Block or to Masonry Walls

While this application is not recommended, when used, it is necessary to take care to observe a 3" edge distance to avoid cracking the block and over penetration of the fastener to avoid loss of holding value. Fastening may be made into the horizontal joint but not into the vertical joint.

Fastening to Steel

Your Ramset tool can be used for fastening on the flat surfaces of structural steel. When fastening into steel, always maintain a minimum spacing of 1-1/2" between fastenings and 1/2" from any edge.

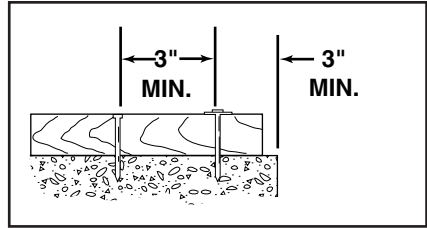

SPACING WOOD TO CONCRETE

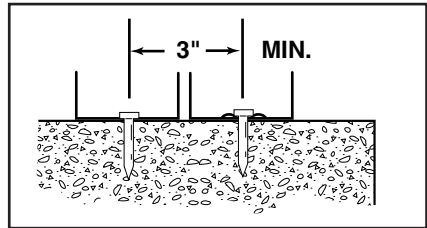

SPACING — THIN GAUGE METAL TO CONCRETE

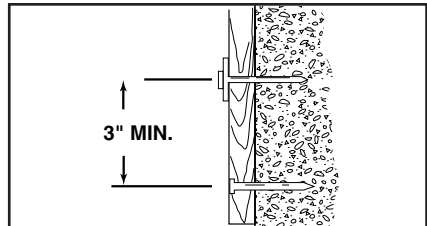

SPACING — FURRING STRIP TO CONCRETE

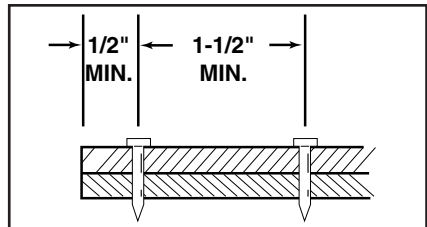

SPACING — STEEL TO STEEL

TOOL OPERATION

DAILY FUNCTION TEST

Always check the tool first to make sure that it does not contain a strip load or fastener. Test the tool several times by depressing the muzzle bushing fully on a hard surface and pulling the trigger. You should hear an audible click as the firing pin releases. Let up on the tool and check to be sure that the barrel has opened to the semi-open position.

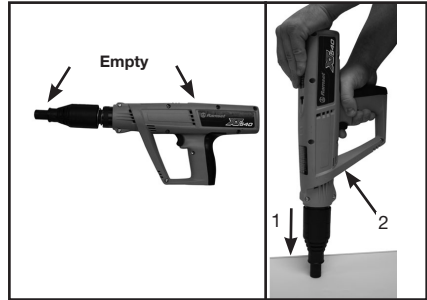

PERFORM THE FUNCTION TEST WITH EMPTY, UNLOADED TOOL

OPERATING THE RAMSET XT540 TOOL

Note: Refer to safety precautions before attempting to operate the tool.

1. Select and insert the fastener.

Select the correct fastener for the application (see Fastener Selection, page 7). Point the tool down and away from yourself and any other person.



1. SELECT AND INSERT THE FASTENER

1a. Tool fitted with single shot fastener guide. Insert a fastener, HEAD FIRST into the fastener guide at the front end of the tool, making sure the fastener guide stays in the forward position.

1b. Tool fitted with fastener magazine.

- 1 - Press the magazine release button.
- 2 - Slide the magazine cover down.
- 3 - Insert Ramset collated drive pins.
- 4 - Push the magazine cover back into the closed position.

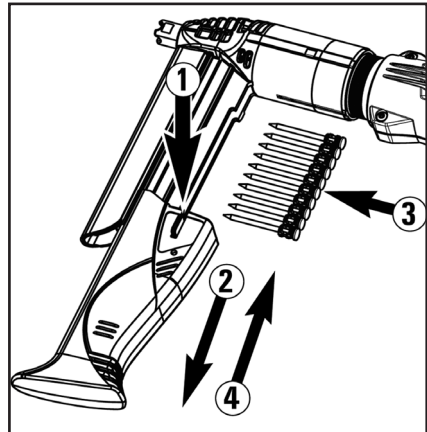

1b. TOOL FITTED WITH FASTENER MAGAZINE

TOOL OPERATING INSTRUCTIONS

2. Insert the power load.

With the tool in the closed position insert a power load strip into the cavity in the base of the rubber handle and push in until the flat of your finger tip is firmly against the handle recess. The first power load is now aligned with the chamber.

Note: Always use the lowest strength power load and lowest power setting first, for a firing test, then adjust the power to suit the job.



2. INSERT THE POWER LOAD

3. Fire the tool.

Press the fastener guide firmly against the work surface, and pull the trigger.

4. **Check the fastener has been correctly set.** (See Fastening Applications, page 8)

5. Adjust the power, if necessary.

Increase power by increasing power setting. When maximum setting is reached, move wheel back to minimum position and insert next strength power load.



5. ADJUST THE POWER, IF NECESSARY

TROUBLESHOOTING

Most commonly, problems are caused by over driving due to poor fastener or charge selection. It is wise to consider these two factors as the first options in trouble shooting.

SYMPTOM	POSSIBLE PROBLEMS SERVICE	
– Fastener over driven	– Too much power	– Use a low strength power load or use the power adjustment feature if applicable
	– Fastener too short	– Select the correct fastener
– Fastener under driven	– Too little power	– Use a higher strength power load or use the power adjustment feature if applicable
	– Fastener too long	– Select the correct fastener
– Rough action	– Excessive carbon build up	– Disassemble, clean and lightly oil tool
– Reduction or loss of power	– Piston not returning to position	– Check the length of the piston Return Spring (Refer to page 13)
	– Faulty piston circlip	– Remove piston. Replace piston circlip
	– Build up of dirt in tool	– Clean tool parts
	– Broken piston	– Replace piston
– Tool misfire	– Failure of tool to depress completely	– Disassemble tool and check all parts for correct assembly after first removing the power loads
	– Cartridge strip damaged	– Remove and replace with new cartridge strip
	– Problem with tool or faulty charge / power load	– Refer to page 5
– Tool Jam	– Damage to power load chamber	– Refer to page 5
– Cartridge strip does not index in tool	– Cartridge strip damaged	– Refer to page 5
	– Strip index mechanism damaged	– Refer to page 5
– Cartridge strip melts	– Tool overheated – fastening rate too high	– Allow the tool to cool. Disassemble tool to increase rate of cooling.
– Cartridge falls out of the strip	– “Hot” tool compressed for too long	– Reduce fastening rate
		– Compress tool for a shorter period of time

PARTS SCHEMATIC

XT540

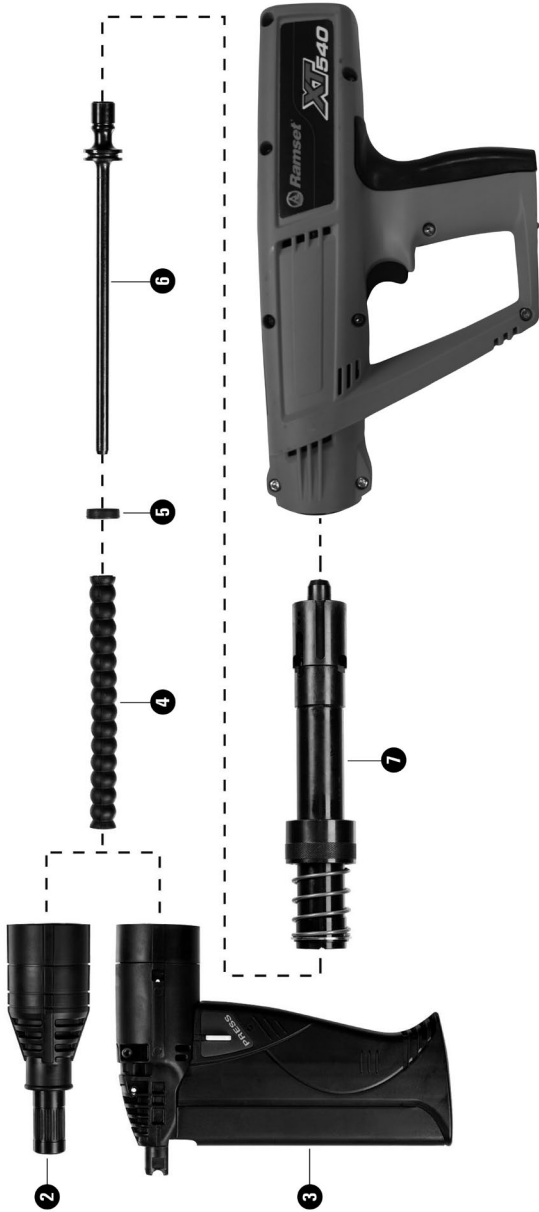

XT540 PARTS LIST

KEY	PART NO.	DESCRIPTION
1	PA37023	SPALL GUARD (NOT SHOWN)
2	PA37040	FASTENER GUIDE ASSEMBLY
3	XTMag	MAGAZINE ASSEMBLY
4	100167	PISTON RETURN SPRING (2)
5	010983	PISTON BUFFER (2)
6	PA37037	PISTON
7	PA37007	BARREL ASSEMBLY
8	N/A	REAR TOOL ASSEMBLY

MAINTENANCE

**IMPROPERLY MAINTAINED TOOLS CAN CAUSE SERIOUS INJURIES
TO TOOL OPERATOR AND BYSTANDERS
CLEAN TOOL DAILY**

Always make sure the tool is not loaded before performing any service or repair and always wear safety goggles when cleaning or servicing the tool.

DAILY CLEANING

All front end parts shown in the disassembly section are to be cleaned daily with a good detergent oil and wire brush. Remove all dirt and carbon buildup and wipe parts dry with a clean rag. Check all parts for wear or damage before reassembly and replace or repair any worn or damaged parts.

PERIODIC COMPLETE CLEANING / GENERAL MAINTENANCE

Heavy or constant exposure to dirt and debris may require that the tool be cleaned more extensively. Complete disassembly and cleaning of all parts may be necessary to restore the tool to normal operation. General maintenance should be performed every six months or more often if the tool is subjected to heavy use. General maintenance/complete cleaning should be done by a qualified repair person.

**ALWAYS FUNCTION TEST THE TOOL AFTER PERFORMING ANY
SERVICE. SEE PAGE 9 FOR DETAILS ON THE FUNCTION TEST.**

INSPECTION / TOOL MAINTENANCE

It is important to clean a Powder Acuated Tool weekly. The carbon build up from the explosive material can decrease the effectiveness of the tool and if not removed, cause long term damage to the tool.

CAUTION: The tool may become hot during operation. Tool maintenance should be performed when the tool has cooled down to avoid the possibility of receiving burns to hands.

1. Ensure that no power loads are loaded in the tool. Remove the power load strip by pulling it upwards out of the tool.
2. Hold the tool vertical with the fastener guide/ magazine pointing upwards. Unscrew the fastener guide/magazine. If this is too difficult by hand, use pliers.
3. Take out the piston assembly (piston, piston return spring and buffer).
4. Push the barrel downwards and unscrew the collar surrounding the barrel. Remove the barrel assembly.
5. Check the length of the return spring using the measuring points located on the top of the tool housing. This check should be made every 3,000 shots.
6. CHECK:
 - The piston tip - replace if it is damaged.
 - The straightness of the piston – if it is not straight, replace it.
 - The piston buffer - replace if it is worn or less than 3/16" thick.
7. Using wire brushes, thoroughly clean all internal and external steel surfaces of any carbon buildup.

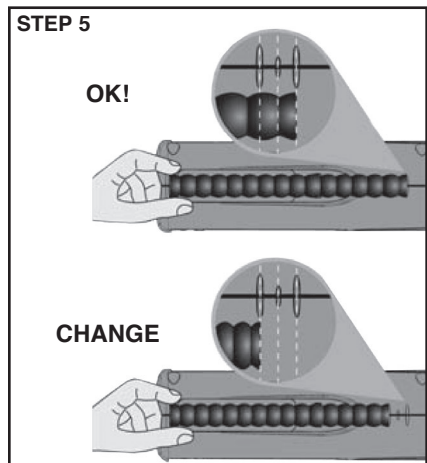
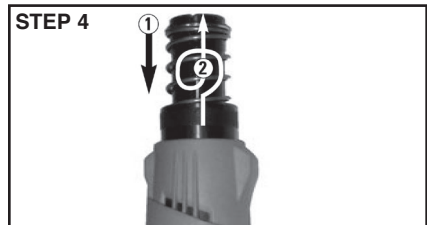
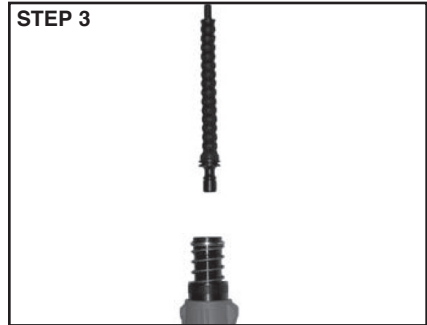

INSPECTION / TOOL MAINTENANCE

Re-assembly is the reverse of disassembly

1. Position the barrel's groove at the top.
2. Insert the barrel's assembly into the main housing and screw the knurled collar by hand. (Do not over tighten).
3. After re-assembly check that the barrel slides properly in the handle.
4. Slide the buffer onto the piston.
5. Slide the piston return spring onto the piston.
6. Insert the piston assembly into the barrel.
7. Screw the magazine or the fastener guide onto the barrel.
8. Without any power loads or fasteners, test the tool for correct function by cocking the tool and depressing the trigger. If this test does not work, do no attempt to use the tool.

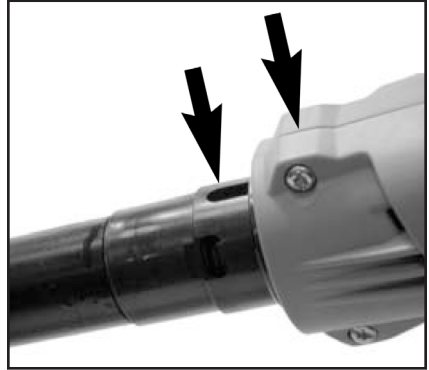

XT540 WARRANTY AND LIMITATIONS

Ramset warrants that new XT540 power fastening tools, parts and accessories will be free from defects in material and workmanship for the period shown below.

THREE-YEAR WARRANTY

A three-year warranty will apply to all parts, except those listed below as normal wearing parts, or parts which are specifically covered by an extended warranty.

The following parts are considered normal wearing parts and are excluded from the warranty:

- Piston • Buffer • Spring Clips
- Pawls • Piston Rings • Piston Return Spring

The warranty period is based off of tool build date, determined from the tool serial number. Ramset may extend the warranty time frame from the date of purchase with a qualifying document proving date of purchase.

WARRANTY STATEMENT

Ramset's sole liability hereunder will be to replace any part or accessory which proves to be defective within the specific time period. Any replacement part or accessory provided in accordance with this warranty will carry a warranty for the balance of the period of warranty applicable to the part it replaces. This warranty does not apply to part replacement required due to normal wear.

This warranty is void as to any tool which has been subjected to misuse, abuse, accidental or intentional damage, use with fasteners, and loads not meeting Ramset specification, size, or quality, improperly maintained, repaired with other than genuine XT540 replacement parts, damaged in transit or handling, or which, in Ramset's opinion, has been altered or repaired in a way that affects or detracts from the performance of the tool.

Ramset MAKES NO WARRANTY, EXPRESSED OR IMPLIED, RELATING TO MERCHANTABILITY, FITNESS, OR OTHERWISE, EXCEPT AS STATED ABOVE and the liability AS STATED ABOVE AND AS ASSUMED ABOVE is in lieu of all other warranties arising out of, or in connection with, the use and performance of the tool, except to the extent otherwise provided by applicable law.

Ramset SHALL IN NO EVENT BE LIABLE FOR ANY DIRECT, INDIRECT, OR CONSEQUENTIAL DAMAGES, INCLUDING, BUT NOT LIMITED TO DAMAGES WHICH MAY ARISE FROM LOSS OF ANTICIPATED PROFITS OR PRODUCTION, SPOILAGE OF MATERIALS, INCREASED COST OF OPERATION OR OTHERWISE.

Ramset reserves the right to change specifications, equipment, or designs at any time without notice and without incurring obligation.

Copyright 2011 Ramset



THE MODEL XT540 TOOL COMPLIES WITH OSHA REQUIREMENTS AND WITH ANSI A10.3 SPECIFICATIONS

FOR TOOL REPAIR SERVICE CONTACT YOUR LOCAL AUTHORIZED RAMSET DISTRIBUTOR OR TO FIND YOUR NEAREST RAMSET TOOL REPAIR CENTER VISIT OUR WEB SITE AT WWW.RAMSET.COM OR CALL 800-241-5640



**Concrete Fastening Systems
Glendale Heights, IL 60139
800-RAMSET6 (1-800-726-7386)
www.ramset.com**

**Buy with Confidence...
Buy From Your Authorized Distributor**

**AN ILLINOIS TOOL WORKS COMPANY
© ILLINOIS TOOL WORKS 2011**